

EasyGate SPD-G

The EasyGate SPD-G speed gate is a solid compact designed security solution. With a small footprint the SPD-G is designed for a high level of throughput. Available in a round and square cabinet design.

MAIN FEATURES

- Low maintenance brushless operation – Patented Magnetic Direct Drive
 - Integration of lift control or ticket reader *
 - High resistance to dust and humidity
 - Compact cabinet width design: 180mm
 - Designed to cope with a high level of throughput
 - Alarm signals and audible notifications
- * Optional upgrade

DIMENSIONS

Cabinet height: 975mm
 Cabinet length: 1500mm
 Cabinet width: 180mm
 Barrier height: 850mm

NUMBER OF WINGS

1 Wing/ 2 Wings

PASSAGE WIDTH

1 wing

Standard width: 550mm
 Max Passage width: 600mm

2 wing

Standard width: 650mm
 Max Passage width: 1050mm

BASE AND HOUSING

Brushed Stainless Steel (AISI 304)

TOP LID

Black Glass Panel

BARRIER

Glass Wing (10mm, tempered)

SIDE INFILL PANEL

6mm tempered glass

POWER SUPPLY

230V AC



COMMUNICATION INTERFACE

RS-485/ USB/ Ethernet

NUMBER OF SENSORS

36 pairs

TAILGATING AND CROSS OVER DETECTION

Yes

CLIMBOVER DETECTION

Yes - electronic detection

RANGE OF OPERATING TEMPERATURE

+10°C to +50°C
 -25°C to +50°C with heating module

OPERATING ENVIRONMENT

Indoor

EMERGENCY MODE

Open manually or automatically
 (with power backup)

BRAKE CONTROL FUNCTION

Brake force in excess of 650N, Hardened tooth lock brake

MCBF

15,000,000 cycles (Based on recommended maintenance schedule)

OPTIONAL ACCESSORIES

- LED lane light
- Edge light
- Wing light
- Hinge capping
- Integrated visitor card collector
- Integrated 3rd party terminals
- Custom Top Lid – Wood/ Stone/ Corian
- Custom Base and Housing – RAL powder coated steel.
Black/ Gold/ Bronze stainless steel
- Stainless steel infill panels
- Low iron glass wings

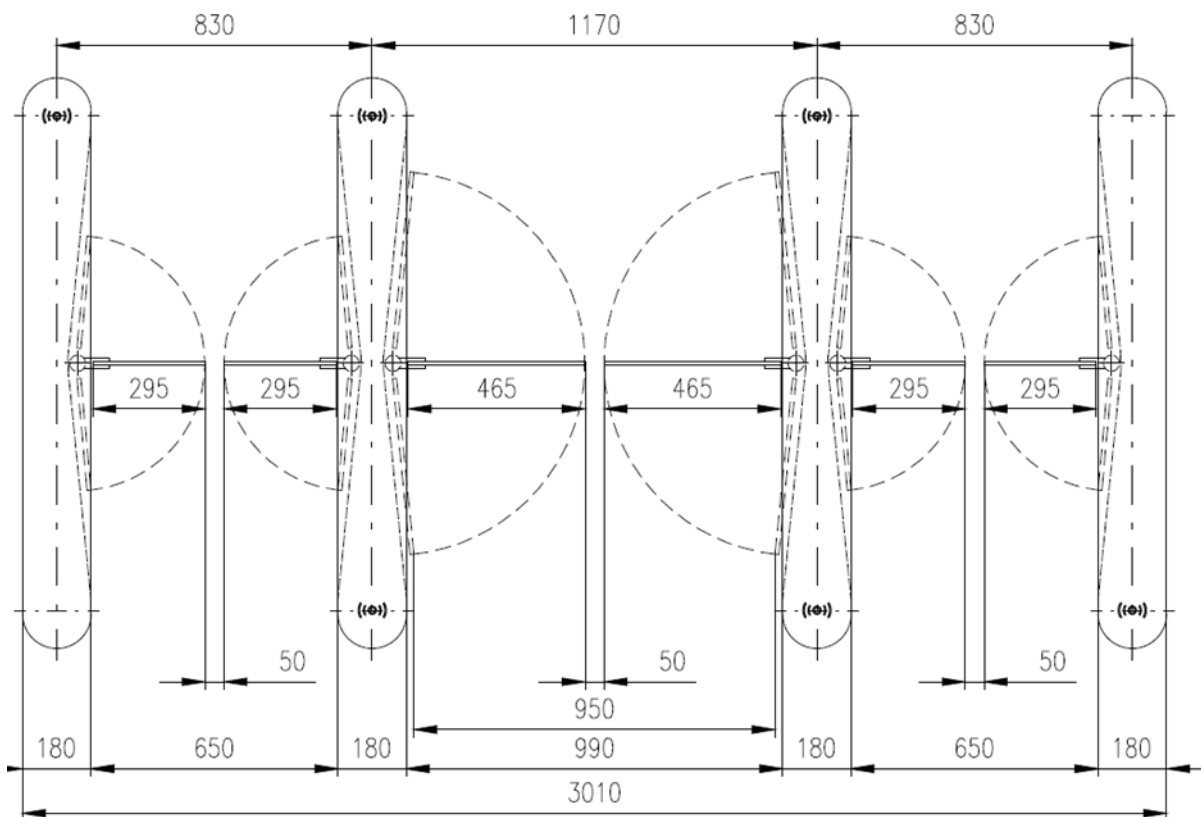
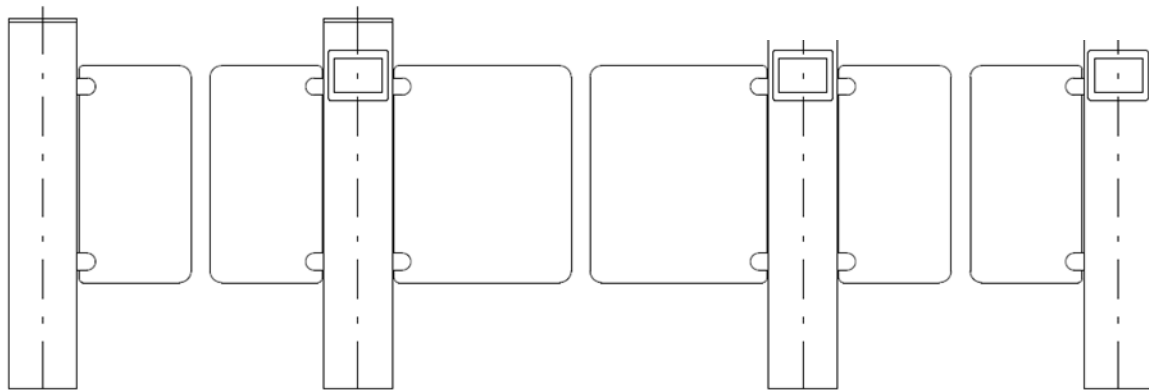
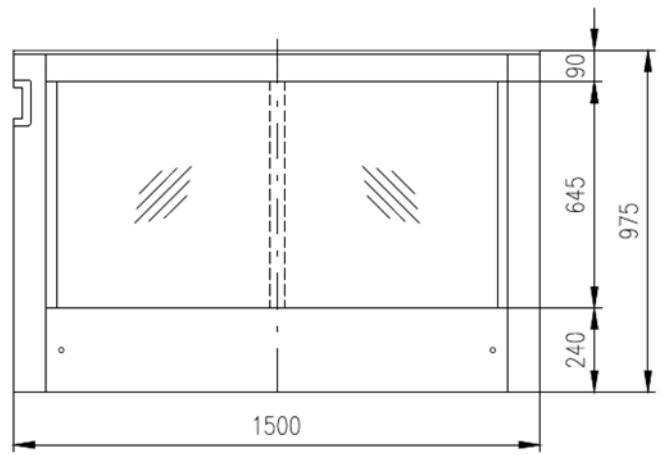

As our policy is to continually improve the products we offer, we reserve the right to amend specifications without prior notice. Further product drawings are available on request